

Model: TPC-6156W
15.6" Multi-Touch Fanless Panel Computer with 6-9th Gen. Intel® Core™ i3/i5/i7 processors



Main Feature

- LED Panel - Higher Brightness; Longer Life Span; Better Viewing Angle; Less Power Consumption ...
- 15.6" Full HD LED Panel support 1920x1080 pixels
- Intel 6/7/8/9th Gen. Intel® Core™ i3/i5/i7 processor
- 8mm Aluminum Magnesium Alloy front bezel
- NEMA4 / IP 65 compliant front panel, with rugged construction design
- Front flat glass (7H Hardness) with projected capacitive Multi Touch Screen
- Supports 10 points multi-touch in Windows 7/8.1/10/11...
- 4 x RS232/485 (with surge protection, auto flow control - for RS485)
- (Optional - WIFI) Mini PCI-E WIFI Module with Antenna
- Panel (Flush) mounting with clip

Application:

- Factory Automation; Processor Automation; Power Generation; Marine / Offshore Industrial; Kiosk ...

Specification	
Product Model	TPC-6156W
CPU	Supports 6/7/8/9 th Gen Intel® Core™ / Pentium® / Celeron® processors for LGA 1151
Chipset	Intel® H110
Memory	2 x DDR4 SO-DIMM Socket up to 64GB
Storage	Space for 1 x M.2 (2280) and 1 x mSATA
Display	Display Type : 15.6" Full HD <u>LED Panel</u> LCD Resolution : 1920 x 1080 Luminance : 250 cd/m2 View Angel : 178° (H), 178° (V)
LAN	3 x Intel® i210 / i211 GbE LAN
USB port	4 x USB 3.0/2.0 and 2 x USB 2.0
Display output	Intel® HD Graphics HDMI output

COM port	4 x optical isolated RS232/485 (with 8KV ESD and 600W Surge protection), RS-485 supporting auto flow control
Expansive interface	1 x Mini PCI-E (full size)
Back panel I/O port	3 x RJ45, 4 x USB 3.0/2.0, 2 x 2.0, 1 x HDMI, 4 x RS232/485, 1 x Power Switch, 8 x DI & 8 x DO, DC input terminal (12-24VDC)
Supporting OS	Windows 10/11; Linux; Real-time operating system (RTOS) such as VxWorks, INtime...
Touch Screen	Internal USB interface controller - Projected Capacitive Multi Touch (10 points) Light transmission: 85% or more Surface hardness : 7H Operation system : DOS; Windows XP / 7 / 8.1 / 10 / 11; Linux
Wireless LAN (optional)	MINI PCI-E WIFI Module with Antenna
Construction	Heavy duty steel and aluminum front panel
Environment	Operating temperature: -10 °C to 60 °C Storage temperature: -20 °C to 80 °C Storage humidity: 10% to 90% non-condensing Vibration operate SSD: 3 Grms, IEC 60068-2-64, random, 5-500 Hz, 1 hr/axis Shock operate SSD: 30 G, IEC 60068-2-27, half sine, 11 ms duration
Compliance	CE; FCC; ROHS
Dimension W x H x D (mm)	405 x 258 x 74
Ordering Information	
TPC-6156W	15.6" Multi-Touch Fanless Panel Computer
(Optional) Intel Processor	Refer to "Processor List"
(Optional) AC to DC Adapter	12VDC/120watt Power Adapter, input 110-240VAC
(Optional) RAM	8 to 64GB DDR4 SO-DIMM RAM
(Optional) SSD / HDD	128GB to 2TB SSD
(Optional) OS	Windows 7, 10, 11 Professional , Windows 10, 11 IoT Enterprise

Structure Diagram (Panel cut-off dimension: 387 x 240mm)

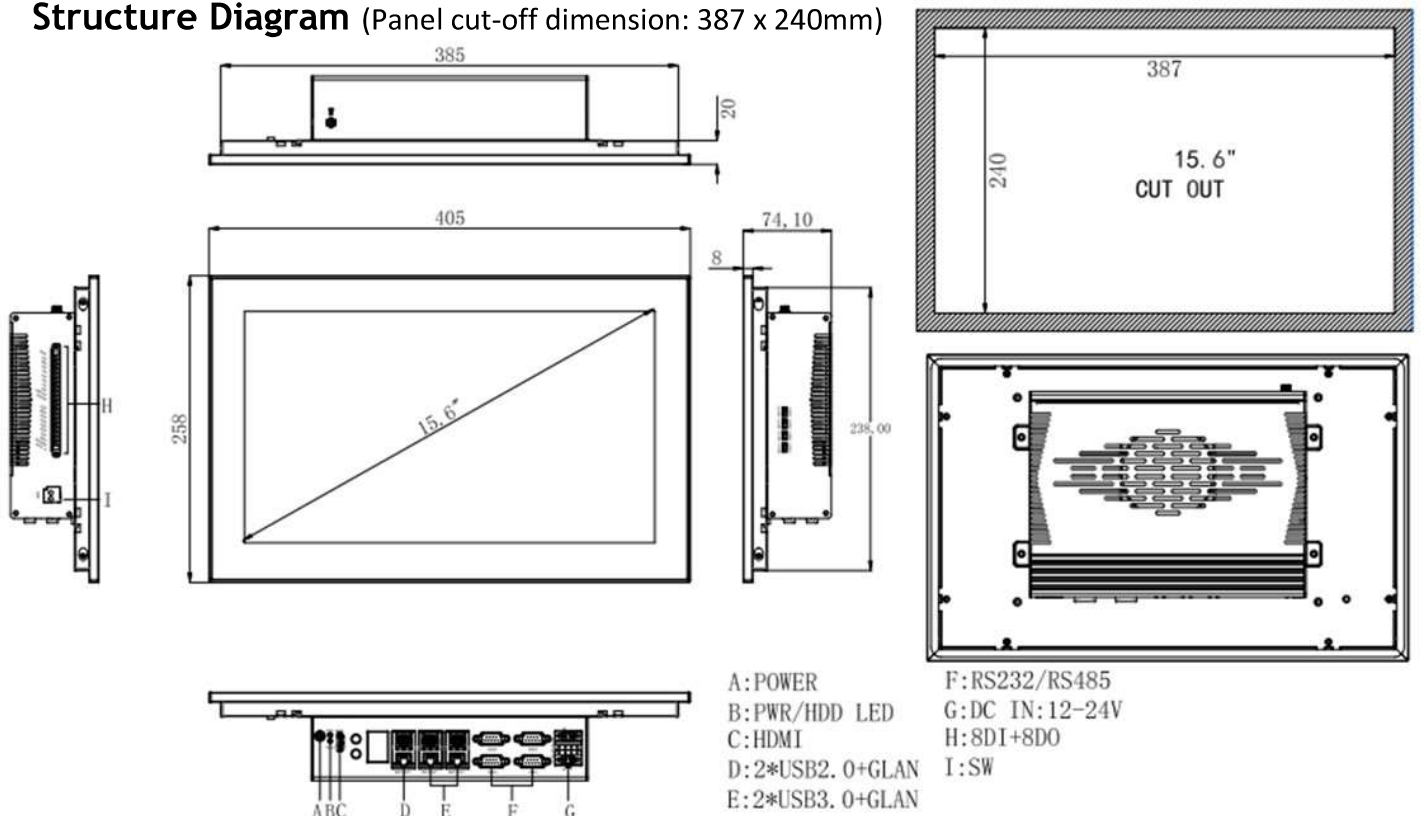

Processor List

Core Name	Processor	CPU No	CPU Speed	Cache	Watt	GPU
Coffee Lake	Core i7	i7-8700T	2.4 - 4.0 (6 x Core)	12M	35	HDGraphics630 1150MHz
Coffee Lake	Core i7	i7-8700	3.2 - 4.6 (6 x Core)	12M	65	HDGraphics630 1150MHz
Coffee Lake	Core i5	i5-8600T	2.3 - 3.7 (6 x Core)	9M	35	HDGraphics630 1150MHz
Coffee Lake	Core i5	i5-8600	3.1 - 4.3 (6 x Core)	9M	65	HDGraphics630 1150MHz
Coffee Lake	Core i5	i5-8500T	2.1 - 3.5 (6 x Core)	9M	35	HDGraphics630 1100MHz
Coffee Lake	Core i5	i5-8500	3.0 - 4.1 (6 x Core)	9M	65	HDGraphics630 1100MHz
Coffee Lake	Core i5	i5-8400T	1.7 - 3.3 (6 x Core)	9M	35	HDGraphics630 1050MHz
Coffee Lake	Core i5	i5-8400	2.8 - 4.0 (6 x Core)	9M	65	HDGraphics630 1050MHz
Coffee Lake	Core i3	i3-8300T	3.2 (4 x Core)	8M	35	HDGraphics630 1100MHz
Coffee Lake	Core i3	i3-8300	3.7 (4 x Core)	8M	62	HDGraphics630 1150MHz
Coffee Lake	Core i3	i3-8100T	3.1 (4 x Core)	6M	35	HDGraphics630 1100MHz
Coffee Lake	Core i3	i3-8100	3.6 (4 x Core)	6M	65	HDGraphics630 1100MHz
Coffee Lake	Pentium	G5600T	3.3 (2 x Core)	4M	35	HDGraphics630 1050MHz
Coffee Lake	Pentium	G5600	3.9 (2 x Core)	4M	54	HDGraphics630 1100MHz
Coffee Lake	Pentium	G5400T	3.1 (2 x Core)	4M	35	HDGraphics610 1050MHz
Coffee Lake	Pentium	G5400	3.7 (2 x Core)	4M	58	HDGraphics610 1050MHz
Coffee Lake	Celeron	G4950	3.3 (2 x Core)	2M	54	HDGraphics610 1050MHz
Coffee Lake	Celeron	G4930T	3.0 (2 x Core)	2M	35	HDGraphics610 1000MHz
Coffee Lake	Celeron	G4930	3.2 (2 x Core)	2M	54	HDGraphics610 1050MHz
Kabylake	Core i7	i7-7700T	2.9	8M	35	HDGraphics630 1150MHz
Kabylake	Core i7	i7-7700	3.6	8M	65	HDGraphics630 1150MHz
Kabylake	Core i5	i5-7600T	2.8	6M	35	HDGraphics630 1100MHz
Kabylake	Core i5	i5-7600	3.5	6M	65	HDGraphics630 1150MHz
Kabylake	Core i5	i5-7500T	2.7	6M	35	HDGraphics630 1100MHz
Kabylake	Core i5	i5-7500	3.4	6M	65	HDGraphics630 1100MHz
Kabylake	Core i5	i5-7400T	2.4	6M	35	HDGraphics630 1000MHz
Kabylake	Core i5	i5-7400	3	6M	65	HDGraphics630 1000MHz
Kabylake	Core i3	i3-7320	4.1	4M	51	HDGraphics630 1150MHz
Kabylake	Core i3	i3-7300T	3.5	4M	35	HDGraphics630 1100MHz
Kabylake	Core i3	i3-7300	4	4M	51	HDGraphics630 1150MHz
Kabylake	Core i3	i3-7100T	3.4	3M	35	HDGraphics630 1100MHz
Kabylake	Core i3	i3-7100	3.9	3M	51	HDGraphics630 1100MHz
Kabylake	Pentium	G4620	3.7	3M	51	HDGraphics630 1100MHz
Kabylake	Pentium	G4600T	3	3M	35	HDGraphics630 1050MHz
Kabylake	Pentium	G4600	3.6	3M	51	HDGraphics630 1100MHz
Kabylake	Pentium	G4560T	2.9	3M	35	HDGraphics610 1000MHz
Kabylake	Pentium	G4560	3.5	3M	54	HDGraphics610 1050MHz
Kabylake	Celeron	G3950	3	2M	51	HDGraphics610 1050MHz
Kabylake	Celeron	G3930T	2.7	2M	35	HDGraphics610 1050MHz
Kabylake	Celeron	G3930	2.9	2M	51	HDGraphics610 1050MHz
Skylake	Core i7	i7-6700T	2.8	8M	35	HDGraphics530 1100MHz
Skylake	Core i7	i7-6700	3.4	8M	65	HDGraphics530 1150MHz

Skylake	Core i5	i5-6600T	2.7	6M	35	HDGraphics530 1100MHz
Skylake	Core i5	i5-6600	3.3	6M	65	HDGraphics530 1150MHz
Skylake	Core i5	i5-6500T	2.5	6M	35	HDGraphics530 1100MHz
Skylake	Core i5	i5-6500	3.2	6M	65	HDGraphics530 1050MHz
Skylake	Core i5	i5-6400T	2.2	6M	35	HDGraphics530 950MHz
Skylake	Core i5	i5-6400	2.7	6M	65	HDGraphics530 950MHz
Skylake	Core i3	i3-6320	3.9	4M	51	HDGraphics530 1150MHz
Skylake	Core i3	i3-6300T	3.3	4M	35	HDGraphics530 950MHz
Skylake	Core i3	i3-6300	3.8	4M	51	HDGraphics530 1150MHz
Skylake	Core i3	i3-6100T	3.2	3M	35	HDGraphics530 950MHz
Skylake	Core i3	i3-6100	3.7	3M	51	HDGraphics530 1050MHz
Skylake	Pentium	G4520	3.6	3M	51	HDGraphics530 1050MHz
Skylake	Pentium	G4500T	3	3M	35	HDGraphics530 950MHz
Skylake	Pentium	G4500	3.5	3M	51	HDGraphics530 1050MHz
Skylake	Pentium	G4400T	2.9	3M	35	HDGraphics510 950MHz
Skylake	Pentium	G4400	3.3	3M	54	HDGraphics510 1000MHz
Skylake	Celeron	G3920	2.9	2M	51	HDGraphics510 950MHz
Skylake	Celeron	G3900T	2.6	2M	35	HDGraphics510 950MHz
Skylake	Celeron	G3900	2.8	2M	51	HDGraphics510 950MHz