

Model: ICM-32WT
32" Industrial Chassis Monitor (Wide Screen), with Touch Screen

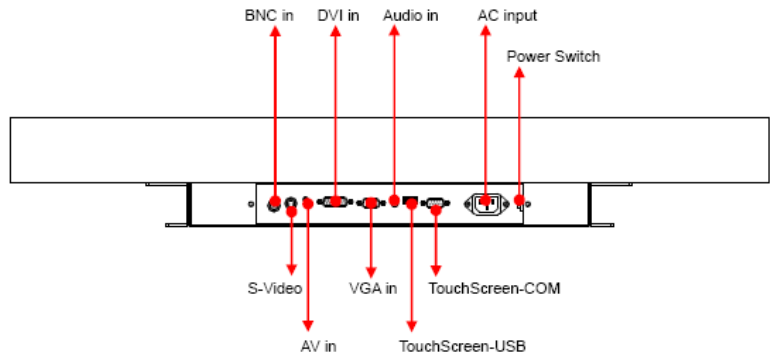

Main Feature

- 31.5" Full HD LED Panel support 1920 × 1080 pixels
- Heavy duty steel chassis with strengthen glass
- Rugged construction design
- Input signal : VGA + DVI + Audio
- Build in 2 x 8 Watts stereo speaker
- OSD control keys to optimize the display
- AC 100-240V wide range external AC adapter
- Meet standard VESA hole

Specification	
Product Model	ICM-32WT
LCD Panel	Display Type : 31.5" Full HD LED Panel Resolution : 1920 x 1080 Max. color : 16.7M Luminance : 450 cd/m2 View Angel : 178° (H), 178° (V) Pixel Pitch : 0.36375 x 0.36375 mm Contrast Ratio : 5000 : 1 Response Time : 8 ms Power Consumption : 65 Watt LCD MTBF : 50,000hrs
Signal Input	VGA (15 pin D-sub connector) + DVI (DVI-D) + audio input (audio jack)
Protect Glass	3 mm strengthen glass
Speaker	Built-in 2x stereo speakers(8 watt)
OSD	Brightness, Contrast, H/V Position, Color, Phase, Clock, PIP, Auto tune and recall
Touch Screen	Internal USB or RS-232 interface controller Type: Surface Acoustic Wave touch Touch Resolution: Above 2048 × 2048

	Light transmission: 90% or more Power consumption: 4.9~5.1V Surface hardness : 7H Response Time Max. 50ms Life expectancy : 50 Million Operation system : Windows 2000 / XP / Vista / 7 / CE, DOS , Linux
Signal Connectivity (optional)	AV input (S-Video, RCA, BNC)
Power Supply	Input: 100~240VAC, 50/60Hz, with 180 Watt internal power board
Construction	Heavy duty steel chassis
Environment	Operating temperature: 0 °C to 50 °C Storage temperature: -20 °C to 60 °C Storage humidity: 10% to 95%, non-condensing Vibration: 17 to 500HZ 1G PTP Shock: 1G /peak(11m sec)
Safety	CE/FCC/Rohs
Dimension W x H x D (mm)	735 x 430 x 80 mm
Weight	NET weight: 19 KG; Gross weight: 22 KG

Ordering Information

ICM-32WT	32" Industrial Chassis Monitor (Wide Screen), with Touch Screen
Optional: AV	Support AV Input (S-Video, RCA, BNC)

Structure Diagram

